

# Operators Manual

## Programmable / Digital Controller Models



# Table of Contents

## Section 1 – General Information

- 1.1 Warranty
- 1.2 Unpacking

## Section 2 – Overview

- 2.1 Circulation Bath
- 2.2 Immersion Circulator

## Section 3 – Circulator Pump Connections and Setup

- 3.1 Circulation Pump
- 3.2 Pump Inlet and Outlet Connections
- 3.3 Closed Loop Circulation
- 3.4 Open Loop Circulation
- 3.5 Filling the Reservoir
- 3.6 Reservoir Purge

## Section 4 – Programmable / Digital Controller Information

- 4.1 Front and Rear Panels
- 4.2 Heater/Pump Assembly
- 4.3 Specifications

## Section 5 – Operation

- 5.1 Circulator Location
- 5.2 Reservoir Liquid Level
- 5.3 External Temperature Probe
- 5.4 RS232 Interface
- 5.5 Power
- 5.6 Setting the Safety Set Point
- 5.7 Power On
- 5.8 Setting the Bath Temperature Set Point
- 5.9 Menu Navigation
- 5.10 Programming the Controller
- 5.11 Controller Messages

## Section 6 – Maintenance and Calibration

- 6.1 Heater
- 6.2 Pump Motor
- 6.3 Cleaning
- 6.4 Maintaining Clear Bath Water
- 6.5 Condenser, Air Vents, and Reusable Filter (Refrigerating/Heating Circulators only)
- 6.6 Calibration

## Section 7 – Troubleshooting

- 7.1 Unit Will Not Operate (No Heat, Cooling, or Pumping)
- 7.2 No Pumping
- 7.3 Slow or Insufficient Pumping
- 7.4 No Heating
- 7.5 Insufficient Heating
- 7.6 No Cooling or Insufficient Cooling
- 7.7 Triac Failure
- 7.8 External Probe Failure
- 7.9 Recalling the Power-Up Language Selection Menu

## Section 8 – Reservoir Fluids

## Section 9 – Service and Technical Support

## Section 10 – Replacement Parts

## Section 11 – Appendix

- 11.1 RS232
- 11.2 Microsoft® Excel Macro
- 11.3 National Instruments LabView™ Plug-in

## Section 12 – EC Declaration of Conformity

## Section 1 - General Information

### 1.1 Warranty

Thank you for purchasing this circulator. We are confident it will serve you for a long time. Our warranty to you is as follows:

The manufacturer agrees to correct for the original user of this product, either by repair, or at the manufacturer's election, by replacement, any defect that develops after delivery of this product within the period as stated on the warranty card. In the event of replacement, the replacement unit will be warranted for 90 days or warranted for the remainder of the original unit's parts or labor warranty period, whichever is longer.

If this product requires service, contact the manufacturer/supplier's office for instructions. When return of the product is necessary, a return authorization number will be assigned and the product should be shipped, (transportation charges pre-paid), to the indicated service center. To insure prompt handling, the return authorization number should be placed on the outside of the package and a detailed explanation of the defect enclosed with the item.

This warranty shall not apply if the defect or malfunction was caused by accident, neglect, unreasonable use, improper service, or other causes not arising out of defects in material or workmanship. There are no warranties, expressed or implied, including, but not limited to, those of merchantability or fitness for a particular purpose which extends beyond the description and period set forth herein.

The manufacturer's sole obligation under this warranty is limited to the repair or replacement of a defective product and shall not, in any event, be liable for any incidental or consequential damages of any kind resulting from use or possession of this product. Some states do not allow: (A) limitations on how long an implied warranty lasts; or (B) the exclusion or limitation of incidental or consequential damages, so the above limitations or exclusions may not apply to you. This warranty gives you specific legal rights. You may have other rights that vary from state to state.

### 1.2 Unpacking

Your circulator is shipped in a special carton. Retain the carton and all packing materials until the unit is completely assembled and working properly. Set up and run the unit immediately to confirm proper operation. Beyond one week, your unit may be warranty repaired, but not replaced. If the unit is damaged or does not operate properly, contact the transportation company, file a damage claim and immediately contact the company where your unit was purchased.

Remove any loose packing material that may have fallen into the reservoir during shipping. Before powering up, check that nothing remains around the heater or circulator pump.

The instructions in this manual pertain to both circulating baths as well as the immersion circulator. Read the section pertaining to the special instructions for your model, then review the instructions for all models of circulators.



This symbol marks chapters and sections of this instruction manual which are particularly relevant to safety.



This symbol indicates that hazardous voltages may be present.

Read all instructions pertaining to safety, set-up, and operation.  
Proper operation is the users' responsibility.

## Section 2 – Overview

### 2.1 Circulating Bath

#### Contents

- Circulating Bath
- Operators Manual
- Warranty Card
- IEC Power Cord
- RS232 Communication Cable
- CD with Datalogging / Control Software<sup>1</sup>
- Tube Fitting Package Containing:



Description	Quantity	Part Number
— 3/16 inch Barbed Tube Fittings	2	300-049
— 1/4 inch Barbed Tube Fittings	2	300-048
— 3/8 inch Barbed Tube Fittings	2	300-047
— Hose, Bypass, Buna N (-40° to 120°C)	1	590-068
— 1/4 inch NPT – M16, Male Adapter Fittings <sup>2</sup>	2	775-290

1. Included with Programmable Controller only

2. Included with 50Hz Models only

#### General Description

Refrigerating/Heating and Heat Only Circulating Baths with the Programmable or Digital Controller are designed for use as stand-alone baths or to provide precise temperature control of fluids for open or closed loop circulation to external equipment. Refrigeration is normally required for operation at temperatures below 40°C.

All Circulating Bath models feature a reservoir, which may be used for immersing samples while the unit is connected to an external device. Circulating Bath models are equipped with a 6, 13, or 28 liter reservoir. All wetted parts are corrosion-resistant 300 series stainless steel.

Model Type	Temperature Range	Reservoir Capacity	Amps @ 120v 60Hz	Amps @ 240v 50Hz
Refrigerating/Heating	-20° to 200°C	6L	12	9.9
Refrigerating/Heating	-30° to 200°C	13L	13	9.8
Refrigerating/Heating	-25° to 200°C	28L	13	9.8
Refrigerating/Heating	-40° to 200°C	13L	14	9.9
Heat Only	Ambient +5° to 200°C	6L	11	9.8
Heat Only	Ambient +5° to 200°C	13L	11	9.8
Heat Only	Ambient +5° to 200°C	28L	11	9.8



**Warning:** These units are equipped with over-temperature protection (Safety Set). A low-liquid level or failure to set the Safety Set and properly immerse the heater may result in heater burnout and triac failure. While operating, do not allow the heater to contact any potentially flammable materials, such as plastic trays or the sides of plastic tanks, as a fire hazard may result.

2.2

Immersion Circulator

Contents

- Immersion Circulator
- Operators Manual
- Warranty Card
- IEC Power Cord
- Tube Fitting Package Containing:



Description	Quantity	Part Number
— 3/16 inch Barbed Tube Fittings	2	300-049
— 1/4 inch Barbed Tube Fittings	2	300-048
— 3/8 inch Barbed Tube Fittings	2	300-047
— Hose, Bypass, Buna N (-40° to 120°C)	1	590-068
— 1/4 inch NPT – M16, Male Adapter Fittings <sup>1</sup>	2	775-290

1. Included with 50Hz Models only

General Description

Immersion Circulators with the Programmable or Digital Controller are designed for use in user-supplied reservoirs. These units can be used with many sizes and shapes of reservoirs, making them extremely versatile and useful for a wide variety of applications. They may be used for open and closed loop applications. Operation of the Controller is the same as that for Circulating Bath models.

Model Type	Temperature Range	Reservoir Capacity	Amps @ 120V, 60Hz	Amps @ 240V, 50Hz
Heat Only Immersion Circulator	Ambient +5°C to 200°C*	N/A	11A	9.7A

Mounting Bridge

The Immersion Circulator features an expandable mounting bridge that may be adjusted to span the top of the user-supplied reservoir. This bridge may be adjusted to widths from 15 to 25 inches (380 to 635 mm).

Attainable Temperatures

An Immersion Circulator can be used with reservoirs of various capacities and shapes as well as with different fluids. These variables may adversely affect temperature accuracy and stability. For example, a reservoir with a large surface area loses heat more quickly, possibly preventing the Circulator from attaining the desired temperature.

The following chart is intended as an approximate guide to temperature performance expectations under various conditions:

**Approximate Attainable Temperatures vs. Liters In Uncovered Reservoir**

Temperature	30°C	40°C	50°C	60°C	70°C	80°C	90°C	100°C	110°C	120°C	130°C	140°C	150°C
<b>Water</b>	192L	96L	48L	24L	12L	6L	3L	–	–	–	–	–	–
<b>Oil</b>	283L	202L	145L	103L	74L	53L	38L	27L	19L	14L	10L	7L	5L

Results may vary.

	<p><b>Warning:</b> These units are equipped with over-temperature protection (Safety Set). A low-liquid level or failure to set the Safety Set and properly immerse the heater may result in heater burnout and triac failure. While operating, do not allow the heater to contact any potentially flammable materials, such as plastic trays or the sides of plastic tanks, as a fire hazard may result.</p>
--	---

## Section 3 – Circulator Pump Connections and Setup

### 3.1 Circulator Pump

The Circulator's five-speed duplex (pressure/suction) pump may be used for tempering of samples in the reservoir or for circulation in open or closed loop systems.

Pump speed is selected via the Main Menu (see Section 5.10 – Selecting the Pump Speed). The MINIMUM setting is adequate for most applications and provides quieter pumping. MAXIMUM is recommended where temperature varies frequently and there is a need for fast recovery or when pumping to multiple external units.

Speed Selection	Maximum Pump Outlet Ratings Line Frequency = 60Hz	Maximum Pump_Outlet Ratings Line Frequency = 50Hz
MAXIMUM	30 LPM / 5.0 PSI	22 LPM / 3.4 PSI
HIGH	24 LPM / 2.5 PSI	20 LPM / 1.7 PSI
MEDIUM	20 LPM / 1.7 PSI	17.5 LPM / 1.2 PSI
LOW	18 LPM / 1.2 PSI	15.8 LPM / 0.8 PSI
MINIMUM	15.7 LPM / 0.8 PSI	15 LPM / 0.7 PSI

The data in the table above are based on the following criteria:

1. Maximum pump outlet flow rate is measured in liters per minute (LPM) with no restriction on the pump outlet.
2. Maximum pump outlet pressure is measured in pounds per square inch (PSI) at no flow.
3. Water was used as the circulation fluid. Water has a viscosity of one centistoke. High viscosity or low-density fluids will change these figures.

### 3.2 Pump Inlet and Outlet Connections

The pump inlet and outlet ports are female ¼ inch NPT connections that permit use of barbed tubing adapters or hard plumbing fittings. ½ inch (13mm) ID tubing may also be slid over these connections and held in place with a hose clamp. If the pump inlet and outlet are not used for external circulation, they should be connected using the Buna N Bypass Hose provided with the unit in order to optimize fluid mixing within the reservoir.

The nylon barbed tubing adapter fittings supplied with the unit are intended for applications from -40° to 93°C. For applications above 93°C, brass, stainless steel, or Teflon® fittings are recommended. ¼ inch NPT to M16 stainless steel male adapter fittings are provided with all 50Hz models.



**Warning! It is the user's responsibility to ensure that the tubing and fittings connected to the Circulator are compatible with the bath fluid and temperature range being used.**

NOTE: The use of quick-connect fittings is not recommended as they typically restrict flow rate.

### 3.3 Closed Loop Circulation

Connect the pump inlet and outlet to the external apparatus. To maintain adequate flow, avoid restrictions in the tubing. When connecting the Circulator to more than two closed loops, the use of a manifold made of "Y" adapters to divide the fluid into multiple banks is recommended. After setting up multiple closed loops, check for adequate flow at the return manifold of each loop and check that the bath fluid is at an adequate level. A booster pump may be added to closed loops without damaging the Circulator's bath pump.

The temperature control stability of a closed loop system is better at the external apparatus than in the Circulator reservoir (provided the control point of the apparatus represents a constant load and is well insulated). For example, if you circulate fluid through a viscometer at 50°C, the temperature variation observed in the Circulator reservoir may be ±0.2°C while the temperature variation in the viscometer may be only ±0.1°C.

Although temperature stability is generally better at the external apparatus control point, depending on the length of tubing used and the efficiency of the insulation, the actual temperature reading at the external apparatus may be slightly different than the temperature reading at the Circulator reservoir.

### 3.4 Open Loop Circulation

The duplex pump permits circulation to and from an external open bath. To prevent siphoning when the Circulating Bath is turned off, position both baths so that the two fluid levels are at the same elevation.

Connect the pump inlet and outlet to the external bath using tubing of the same diameter and length. The same size fittings should also be used on both the inlet (suction) and outlet (pressure). This helps ensure a balanced flow. A restricting valve or pinch clip should be installed in the pressure (outlet) tubing and adjusted to match the return suction (inlet) flow rate. Cut the external end of the suction tube into a "V" shape so that the tube will not seal itself against the wall of the external tank. Both the pressure and suction tubing should be securely fastened to the external tank to prevent movement during use.

When using flexible tubing, the suction tubing must have a wall thickness that will not collapse under vacuum, particularly when going around bends.

**Circulating Bath Height Regulation** — Position the ends of the pressure and suction tubes at the desired maximum fluid level in the external bath and fill the bath to that level. Fill the Circulating bath to a height one inch (25mm) below the top of the reservoir. Start the pump and adjust the restricting valve/pinch clip on the pressure tubing until the liquid height in both baths remains constant. Add fluid to the baths as needed to compensate for the fluid in the inlet and outlet lines.

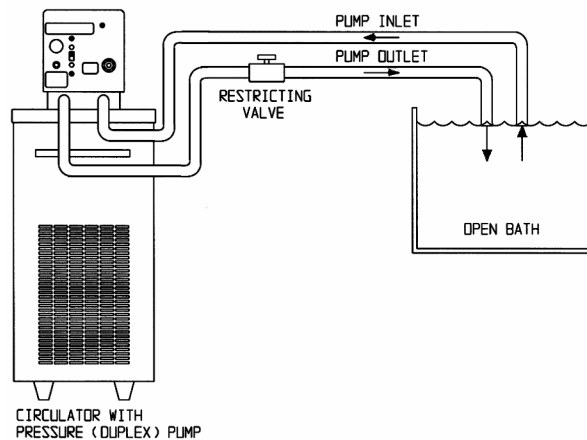

### 3.5 Filling the Reservoir

The maximum fill level for the Circulating bath is one inch (25mm) below the top of the reservoir. A liquid level that fully covers the heater coil, pump, over-temperature sensor, and at least one inch (25mm) of the temperature sensor must be maintained. For optimum cooling efficiency, the bath fluid level in Refrigerating/Heating Circulators should be kept above the cooling coils at all times.

Upon start-up, it may be necessary to add fluid to compensate for the fluid required for external circulation. If the proper fluid level is not maintained, the heater coil may become exposed and possibly damaged.

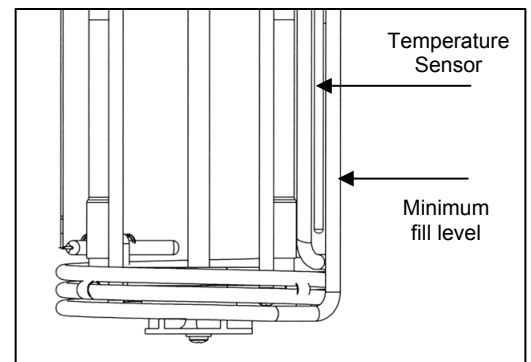

### 3.6 Reservoir Purge

When operating at low temperatures, atmospheric moisture tends to migrate into the reservoir and condense. The 1/8 inch OD Reservoir Purge tube allows you to inject inert gas into the Circulating Bath to prevent the build-up of condensation.



## Section 4 - Programmable / Digital Controller Information

### 4.1 Front and Rear Panels

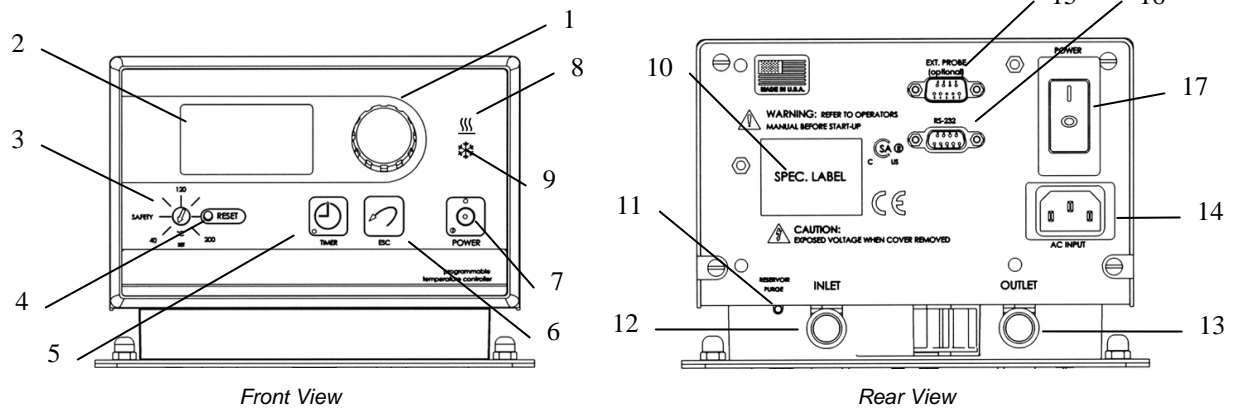

- |                               |  |
|-------------------------------|--|
| 1. Select / Set Knob          | 10. Identification Label                   |
| 2. LCD Display                | 11. Reservoir Purge                        |
| 3. Safety Set Indicator Knob  | 12. Pump Inlet                             |
| 4. Safety Set Reset Button    | 13. Pump Outlet                            |
| 5. Timer Button               | 14. AC Input                               |
| 6. Escape Button              | 15. External Probe Connection <sup>2</sup> |
| 7. Power On/Off Button        | 16. RS232 Interface                        |
| 8. Heating Light              | 17. Circuit Breaker / AC Power Switch      |
| 9. Cooling Light <sup>1</sup> |  |

<sup>1</sup> Active on Refrigerating/Heating Circulating Baths only

<sup>2</sup> Functional on Programmable Controller only.

### 4.2 Heater/Pump Assembly

1. Temperature Sensor
2. Pump Shaft and Impeller
3. Over-Temperature Sensor
4. Heater Coils

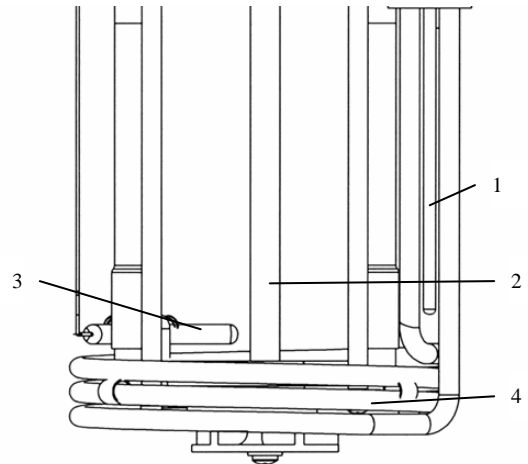



## 4.3

## Specifications

Temperature Stability <sup>1</sup>	±0.01°C
Controller / RS232	Yes
External Temperature Probe	Functional on Programmable models / optional external probe required Not functional on Digital models
Readout Accuracy	Graphic LCD, °C or °F, ±0.25°C
Heater	1100W – 115V, 2200W – 240V
Pressure Flow Rate	15.7 to 30 LPM (60Hz); 15 to 22 LPM (50Hz)
Suction Flow Rate	11 to 22 (60Hz); 10 to 15 LPM (50Hz)
Over-Temperature Protection	Yes, user-adjustable
Low-Liquid Protection	Yes
Pump Speeds	Five-speed adjustable
Pump Inlet and Outlet	¼ inch FPT rear discharge.

*1. Temperature stability may vary depending on bath volume, surface area, insulation, and type of fluid.*

NOTE: Performance specifications determined at ambient temperature of 20°C (68°F).

## Environmental Conditions:

- Indoor Use Only
- Maximum Altitude: 2000 meters
- Relative Humidity: 80% for temperatures to 30 C
- Class 1: Residential, Commercial, Light Industrial
- Over Voltage: Category II
- Operating Ambient: 5 to 30 C
- Pollution Degree: 2
- Class 2: Heavy Industrial

## Section 5 – Operation

### 5.1 Circulator Location

Locate the Circulator on a level surface, free from drafts and out of direct sunlight. Do not place it where corrosive fumes, excessive moisture, high room temperatures, or excessive dust are present.

Refrigerating/Heating Circulators must be a minimum of four inches (102mm) away from walls or vertical surfaces so air flow around the unit is not restricted.

To help prevent voltage drops, position the Circulator as close as possible to the power distribution panel and a properly grounded outlet. The use of an extension cord is not recommended.



**Warning:** These units are equipped with over-temperature protection (Safety Set). A low liquid level or failure to set the Safety Set and properly immerse the heater may result in heater burnout and triac failure. While operating, do not allow the heater to contact any potentially flammable materials, such as plastic racks or the sides of plastic tanks, as a fire hazard may result.

### 5.2 Reservoir Liquid Level

Fill the reservoir with the appropriate bath fluid (refer to Section 8 – Reservoir Fluids). On Circulating Baths, the liquid level should be sufficient to cover the heating coils, cooling coils (if applicable), pump, over-temperature sensor, and at least one inch (25mm) of the temperature sensor (refer to Section 3.5 – Filling the Reservoir). The level should be approximately 1.5 inches (38mm) below the deckplate. On Immersion Circulators, the liquid level should be sufficient to fully immerse the heater coils, over-temperature sensor, and pump outlet nozzle.



After filling the reservoir with fluid, you must set the Safety Set and the Limit High value as well as your desired control set point temperature.

### 5.3 External Temperature Probe

The Programmable Controller is designed to accommodate an optional remote temperature probe. The probe attaches to the 9-pin male D-connector on the rear panel of the Controller.

**NOTE:** On Digital Controllers, this connection is present, but not functional.

The Controller will automatically sense the presence of the external probe when main power (rear panel circuit breaker/power switch) is turned On. To control temperature using the external probe, "External" must be selected via the Controller's software. You must also set a Maximum Setpoint Differential value. See Section 5.10 – Selecting the Temperature Probe.

To attain better temperature uniformity when using the external temperature probe in a jacketed or air-filled vessel, stirring the external fluid with pumps or mixing air with fans is recommended. Expect only  $\pm 1.0^{\circ}\text{C}$  stability with air or any medium that does not conduct heat well. Insulate and cover the entire set-up to remove temperature gradients; the Controller cannot compensate for external chamber or component temperature gradients.

### 5.4 RS232 Interface

Programmable and Digital Controllers incorporate an RS232 interface to provide remote data-logging and control capability. Remote control capability is available on the Programmable Controllers only. The 9-pin female RS232 connector is located on the rear panel of the Controller.

The RS232 interface should be connected to a serial communication port on a remote PC using an appropriate cable. Information on the RS232 command and communication protocol can be found in Section 11.1 – RS232.

Communications software compatible with Microsoft® Excel and National Instruments LabView™ are provided with Programmable Controllers. Information on this software can be found in Section 11.2 – Microsoft Excel Macro and Section 11.3 – National Instruments LabView Plug-in.

## 5.5 Power

An IEC power cord is provided with the Circulator. This power cord should be plugged into the IEC receptacle on the rear of the Controller and then plugged into a properly grounded outlet. Make sure that the power outlet is the same voltage and frequency indicated on the identification label on the back of the Controller.

The use of an extension cord is not recommended. However, if one is necessary, it must be properly grounded and capable of handling the total wattage of the unit. The extension cord must not cause more than a 10% drop in voltage to the Circulator.

Once the unit has been connected to an appropriate electrical outlet, place the Circuit Breaker/Power Switch on the rear of the Controller in the ON position. The unit will run through a self-test.

The first time power is applied to the Controller, the following display will appear. This display allows you to select the language that will be used for all subsequent displays. The instructions for selecting a language will be briefly displayed in each available language.



NOTE: The language selection display only appears the first time the Controller is powered up. See Section 7 – Troubleshooting for information on recalling this display.

When the language selection display appears, rotate the Select/Set Knob until the desired language is highlighted and then press the Select/Set Knob. The Controller will continue with the start-up sequence and then display “Standby” on the LCD.



DO NOT place the Power Switch on the front of the Controller ON until the Safety Set has been adjusted to the desired temperature (see Section 5.6 below).

## 5.6 Setting the Safety Set Point

The Safety Set feature automatically disconnects Controller power to the heater and pump in the event that the reservoir liquid level drops too low or the sensed temperature exceeds the Safety Set temperature. The Safety Set is user-adjustable between approximately 40° and 210°C. It should be set at least 5°C higher than the desired bath temperature.

Use a flat blade screwdriver to rotate the Safety Set Indicator Knob to the desired temperature. Do not force the knob beyond the stops at either end of the temperature value range.

If the Safety Set temperature is exceeded during normal operation, a fault message will flash on the display and power to the heater and pump will be disrupted. To reset the fault, correct the problem (low liquid level, incorrect Safety Set temperature, etc.), press the Safety Set Reset Button, and then the ESC Button. Normal operation will resume.

## 5.7 Power On

Once the Safety Set temperature has been set, turn power to the Controller ON by pressing the Power Switch on the front of the Controller. The following message will appear briefly on the display:

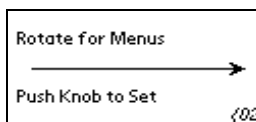

The pump will begin operating; the display will show the current bath temperature and the set point temperature (Setpoint). If an external probe (Programmable Controllers only) is connected, both the

internal and external bath temperatures will be displayed. The temperature probe selected to control bath temperature (internal or external) will be displayed in larger numerals.



NOTE: If the external temperature probe is selected to control bath temperature, but the temperature difference between the set point temperature and the internal bath temperature exceeds the Maximum Setpoint Differential setting, the heating/cooling rate will be controlled using the internal bath temperature until the set point/internal bath temperature difference is within the Maximum Setpoint Differential value. The word Internal will be highlighted on the display to indicate that the internal sensor is controlling bath temperature. See Selecting the Temperature Probe in Section 5.10 for more information.

## 5.8 Setting the Bath Temperature Set Point

Press and release the Select/Set Knob. The “whole” numbers in the set point temperature will be highlighted. Rotate the Select/Set Knob clockwise to increase the displayed value; rotate the knob counter-clockwise to decrease the displayed value.

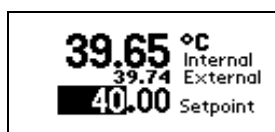

Press the Select/Set Knob to accept the new value. The decimal value in the set point temperature digits will be highlighted. Rotate the Select/Set Knob clockwise to increase the displayed value; rotate the knob counter-clockwise to decrease the displayed value. Press the Select /Set Knob to accept the new value.

NOTE: Increasing/decreasing the decimal value past “0” will cause a corresponding change in the “whole” number value. For example, if the current set point value is 24.8 and the desired value is 25.2, it is not necessary to change the 24 to a 25; increasing the decimal value from .8 to .2 will automatically increase the 24 to 25.

The Controller will not allow you to enter a set point value above the Limit High setting or below the Limit Low setting. Should you attempt to do so, the set point value will stop increasing/decreasing when the Limit value is reached and a Warning message will appear on the display. You must either change the set point or change the Limit value. See Section 5.10 – Setting High/Low Temperature Limits and Alarms.

NOTE: Programmable Controllers can also be operated using a programmed Time/Temperature profile. See Entering/Modifying a Temperature Program and Running a Temperature Program in Section 5.10 for more information.

## 5.9 Menu Navigation

Main Menu — To view the Main Menu items, rotate the Select/Set Knob. Continue turning the Select/Set Knob to scroll through the Main Menu displays.

To begin programming or view the options available in a Main Menu item, press the Select/Set Knob. The first available sub-menu item (or the last item in that sub-menu which was selected) will be highlighted like **THIS**.

To de-select an item, press the ESC Button. To return to the main operational display, press the ESC Button a second time or allow the display to timeout.

Sub-Menu Selections — To select an item in a sub-menu, press the Select/Set Knob. The first available item (or the last item in that sub-menu which was selected) will be highlighted. Rotate the Select/Set Knob clockwise to advance to the next sub-menu item; rotate the knob counter-clockwise to go back to the previous item. Press the Select/Set Knob to select the highlighted item; the highlighting will change from **THIS** to THIS, indicating that the displayed value or choice may be changed.

Entering and/or Changing Sub-Menu Values — Once the desired sub-menu item has been selected (as described above), the displayed value is changed by rotating the Select/Set Knob. The change is accepted by pressing the Select/Set Knob. On sub-menu items requiring multiple entries, such as hours/minutes/seconds, an underline will appear under the first value in that sequence which can be

changed. (Example: 01:23:00 ) To accept the displayed value and/or advance to the next value in the sequence, press the Select/Set Knob. To return to the previous cursor position, such as from minutes back to hours, press the ESC Button. Once a value has been entered and accepted, the highlighting box around the value will disappear. If you do not wish to accept the displayed value, press the ESC Button or allow the display to timeout before pressing the Select/Set Knob.

### Menu Structure

Main Menu Item	Associated Sub-Menu Items	Choices / Ranges / Comments
Timer	Set Beep	00:00:00 to 99:59:59 On or Off
Program <sup>1</sup>	Program # Program Steps Program Loops Step # Step Setpoint Minutes/Seconds View Profile	1 to 10 1 to 50 1 to 99 1 to 50 -50° to 200°C (-50° to 392°F) 0 second to 999 minutes, 59 seconds Displays temperature profile of program.
Run Program <sup>1</sup>	Program # Program Status	1 to 10 Start, Starting, Running, Paused, or Completed
Preferences	Readout Units Sound Language Program <sup>1</sup>	#, ##, or ### (0, 1, or 2 decimal places) °C or °F 1 to 100 English / French / German / Spanish Time / Temperature
Limits / Alarms	Limit High Alarm High Alarm Low Limit Low	-50° to 200°C (-58° to 392°F) -50° to 200°C (-58° to 392°F) -50° to 200°C (-58° to 392°F) -50° to 200°C (-58° to 392°F)
Pump/AutoTune	Pump speed AutoTune	Maximum / Fast / Medium / Slow / Minimum Displays status of AutoTune procedure
Temperature Trend	No sub-menu; displays temperature profile	2 minutes to 48 hours
Probe <sup>1</sup>	Internal / External Maximum Setpoint Differential	Probe currently selected is shown Only displayed when External is selected 1° to 10°C range
Auto Refrigeration <sup>2</sup>	Refrigeration On Setpoint	20° to 70°C 20° to 85°C on units with Cool Command
Instrument	Contrast Timeout Baud Rate	00 to 30 5 to 60 seconds 110 / 300 / 600 / 1200 / 2400 / 4800 / 9600 / 14400 / 19200 / 38400 / 57600

1. These Main Menu items are present on Programmable Controllers only.

2. This Main Menu item is present on Refrigerating/Heating Circulators only.

NOTE: There are additional displays after "Instrument " in the Main Menu. However, there are no user-settable functions on these displays.

## 5.10 Setting Operational Parameters and Functions

All operational parameters and functions are programmed and controlled via the Controller's software settings. Most are user-adjustable and easily accessed via the Main Menu. The Main Menu is accessed by rotating the Select/Set Knob. A particular Main Menu item is selected by pressing the Select/Set Knob when that item is highlighted.

### Setting and Starting the Timer

Timer	34°C
Set	<b>00:00:05</b>
Beep	<b>ON</b>
Status	Ready +000:00:00

The Timer sub-menu allows you to program the Controller's timer to alert you once a specific period of time has elapsed. It should be used as you would an external timer.

**IMPORTANT:** The Timer is independent of temperature control. It does not start or stop heating/cooling. The Controller continues maintaining temperature at the set point even though the designated time period has elapsed.

To set the timer, access Timer on the Main Menu, select Set, and then enter the desired period of time. The timer's audible signal can be turned On and Off via the selection named Beep on the Timer sub-menu.

To start the timer, press the Timer button on the Controller's front panel. A timer icon and Beep icon (indicating either On – or Off – the icon with an X through it), along with a countdown timer, will appear on the bottom of the LCD. The Timer LED will light continuously.

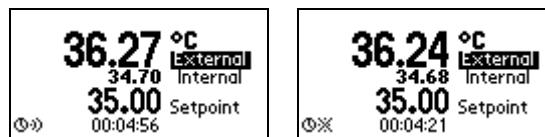

Once the designated time period has elapsed, the audible signal (if enabled) will sound and the countdown timer will display the amount of time which has elapsed since the designated time period ended. The timer LED will flash.

To silence the audible signal and/or clear the timer display from the LCD, press the Timer Button.

The timer may also be paused at any time during the countdown period by pressing the Timer Button. When this occurs, the Timer LED will flash and the word "Paused" will appear on the display adjacent to the countdown timer.

## Entering/Modifying a Temperature Program

NOTE: This function is available on Programmable Controllers only. See Writing a Temperature Program below for information on creating a time/temperature profile.

```
Program 03 50 01 44°C
Step    Set    mmm:ss
01      1.01 ° 001:41
02      1.02  001:42
View Profile 001:44:35
```

This menu selection allows you to program and store up to ten individual time/temperature profiles. Each program can have up to 50 steps and 99 program loops. Once a program has been entered, any portion of it may be modified.

Program # — This is the identification number assigned to the program. It is used to select/run the program (see Running a Temperature Program below). You may enter a number from 1 to 10. If you enter a number that has been assigned previously, any changes made overwrite the prior program.

```
Program 01 50 01 36°C
Step    :Program#  n:ss
01      0.01 ° 000:01
02      0.02  000:02
View Profile 000:21:15
```

Program Steps — This is the number of steps in the program. A program can have from 1 to 50 different steps.

NOTE: If you are modifying a program and change the number of steps (e.g., reduce the number of steps from 25 to 10), steps 11 through 25 will no longer appear. However, if you later increase the number of steps in that program (e.g., from 10 to 15), the original programming for steps 11 through 15 will reappear.

```
Program 01 50 01 36°C
Step    Set  #Steps  n:ss
01      0.01 ° 000:01
02      0.02  000:02
View Profile 000:21:15
```

Program Loops — This is the number of times the program will run before stopping. A program may be repeated up to 99 times.

```
Program 01 50 01 36°C
Step    Set  #Loops  n:ss
01      0.01 ° 000:01
02      0.02  000:02
View Profile 000:21:15
```

Step #, Set, MMM/SS — This is the temperature set point and time for the selected step in the program.

```
Program 01 50 01 36°C
Step    Set    mmm:ss
01      0.01 ° 000:01
02      0.02  000:02
View Profile 000:21:15
```

To enter the set point and time for the step, rotate the Select/Set Knob until a Step number is highlighted like **THIS**. Press the Select/Set Knob again; the highlighting will now look like **THIS**. Rotate the Select/Set Knob to scroll to the desired Step number and press the Select/Set Knob. The boxed highlighting will move to the temperature set point field associated with that step.

```
Program 01 50 01 36°C
Step    Set    mmm:ss
01      40.00 ° 000:01
02      0.02  000:02
View Profile 000:21:15
```

Rotate the Select/Set Knob until the desired temperature set point is displayed. You may advance the cursor (underline) to the next number in the set point field by pressing the Select/Set Knob. Press the ESC Button to return to the previous cursor position.

Once the temperature set point has been entered, press the Select/Set Knob to advance to the time (minutes/seconds) field. Time information is entered the same way as the temperature set point information.

Program	01 50 01	36°C
Step	Set	mmm:ss
01	40.00	030:00
02	0.02	000:02
<b>View Profile</b> 000:51:14		

When you press the Select/Set Knob to accept the time displayed time information, the highlighted box will automatically advance to the set point temperature field associated with the next step of the program.

**IMPORTANT:** The time field establishes the amount of time the Controller should take to reach the temperature set point for the next step (i.e., the ramp rate).

**View Profile** — This allows you to view the programmed time/temperature profile step-by-step. Rotate the Select/Set Knob to move through the various steps in the program. When the cursor (a vertical line) reaches the beginning of a step, a message box will appear displaying the step number, set point, and time.

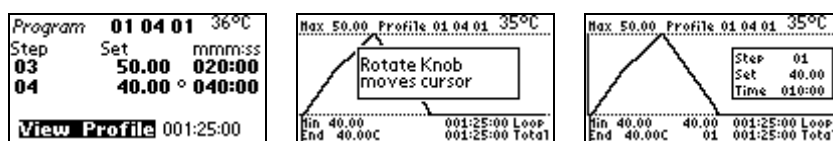

To return to the main operational display, press the ESC Button or allow the display to timeout.

### Writing a Temperature Program

Programmable Controllers permit the user to create up to 10 different time/temperature programs, each of which can have as many as 50 steps and be repeated up to 99 times. The following information is intended to provide you with some guidelines for creating useful programs.

1. Circulating baths are designed primarily to hold temperatures constant rather than change temperatures rapidly. Do not underestimate the amount of time the circulator needs to heat or cool a fluid to a given temperature. Larger baths or circulators being used in closed or open loops will need more time to reach a programmed set point.
2. Programs may be run using either a Time- or Temperature-based priority. If achieving successive temperature set points is critical, Temperature should be selected as the priority. If completing a program in a fixed amount of time is essential, Time should be selected as the priority. See Section 5.10 – Preferences for more information.
3. If a program must run within a set period of time (Time priority), have the bath temperature at or very close to the initial set point before starting the program. The program will not start running until the set point temperature programmed for the first step is achieved.
4. To incorporate a “soak” period in the program, enter the same set point for two adjacent steps in the program. The time duration programmed for the first step should equal the desired “soak” period; the time duration for the second step should be short (e.g., 1 second). The temperature set point for the last step in a program also functions as an indefinite “soak”. The Controller maintains temperature at the last programmed set point until a new set point is entered.
5. The step time in a program establishes the ramp rate that will be used to reach the programmed set point for the next step. If you want to increase/decrease temperature slowly, set a lengthy step time. If you want to increase/decrease as fast as possible, set a short step time. Keep the heating/cooling capabilities of your instrument in mind, however. If you are running a program using Time-based priority, fluid temperature may not reach a desired set point temperature if the time allotted is too short.



Programming Examples

*Example A*

Initial Bath Temperature = 25°C  
 Program Priority = Temperature

Desired Profile: Cool bath temperature to 20°C and hold it there for 25 minutes.  
 Increase bath temperature to 30°C and hold it there for 15 minutes.  
 Increase bath temperature to 50°C over a 45 minutes period.  
 Decrease bath temperature to 5°C and hold.

This example requires a 6-step program:

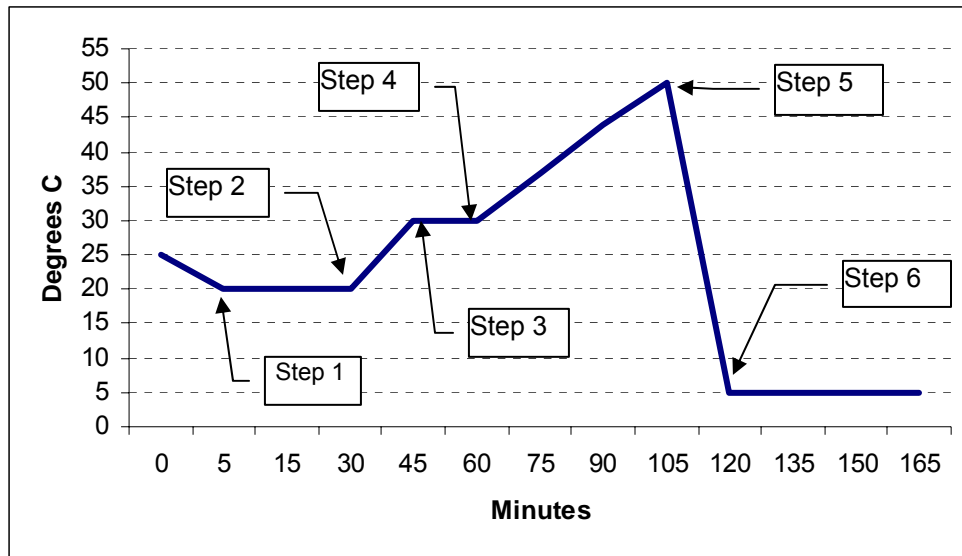

Program Step	Step Set Point	Step Duration	Controller Operation
1	20°C	5 minutes	Controller cools fluid to 20°C as fast as possible. Until 20°C temperature set point is achieved, "Starting" appears on the display. When fluid temperature reaches 20°C, "Running" appears on the display. Fluid temperature maintained at 20°C for 25 minutes.
2	20°C	1 second	Controller heats fluid as fast as possible until the 30°C set point programmed for Step 3 is reached.
3	30°C	15 minutes	Fluid temperature is maintained at 30°C for 15 minutes.
4	30°C	45 minutes	Controller slowly heats fluid until 50°C set point programmed for Step 5 is reached. Ramp rate is based on the 45 minute step duration.
5	50°C	1 second	Controller then cools fluid as fast as possible until 5°C set point programmed for Step 6 is reached.
6	5°C	1 second	"Complete" appears on display. 5°C fluid temperature is maintained until set point is changed.

*Example B*

Initial Bath Temperature = 25°C  
 Program Priority = Temperature

Desired Profile: Cool bath temperature to 20°C and hold it there for 10 minutes.  
 Decrease bath temperature to 10°C over 15 minutes.  
 Hold bath temperature at 10°C for 15 minutes.  
 Increase bath temperature to 50°C over a 1-hour period.

This example requires a 5-step program:

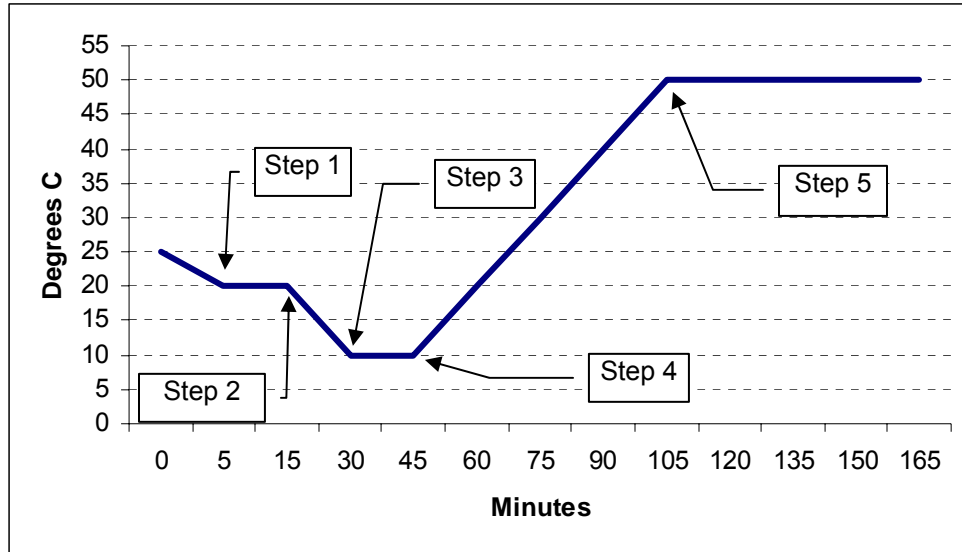

Program Step	Step Set Point	Step Duration	Controller Operation
1	20°C	5 minutes	Controller cools fluid to 20°C as fast as possible. Until 20°C temperature set point is achieved, "Starting" appears on the display. When fluid temperature reaches 20°C, "Running" appears on the display. Fluid temperature is maintained at 20°C for 10 minutes.
2	20°C	15 minutes	Controller cools fluid to 10°C set point programmed for Step 3. Ramp rate is based on the 15 minute step duration.
3	10°C	15 minutes	Fluid temperature is maintained at 10°C for 15 minutes.
4	10°C	1 hour	Controller slowly heats fluid until 50°C set point programmed for Step 5 is reached. Ramp rate is based on the 1 hour step duration.
5	50°C	1 second	"Complete" appears on the display. 50°C fluid temperature is maintained until set point is changed.

*Example C*

Initial Bath Temperature = 25°C  
 Program Priority = Temperature

Desired Profile: Cool bath temperature to 20°C as fast as possible.  
 Increase bath temperature to 55°C as fast as possible.  
 Repeat 7 times.

This example requires a 2-step program with the number of loops set to 8:

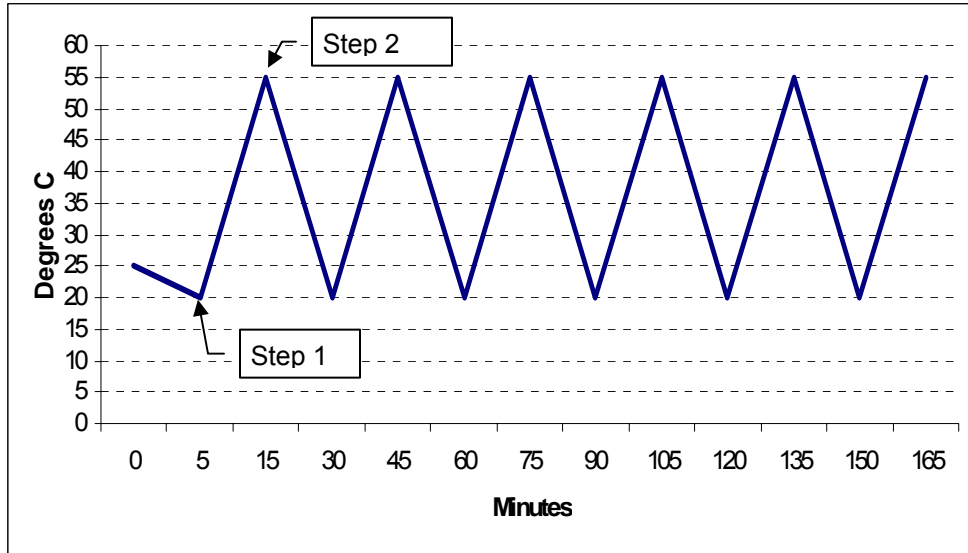

Program Step	Step Set Point	Step Duration	Controller Operation
1	20°C	1 second	Controller cools fluid to 20°C as fast as possible. Until 20°C temperature set point is achieved, "Starting" appears on the display. When fluid temperature reaches 20°C, "Running" appears on the display. Controller applies heat until 55°C set point for Step 2 is reached.
2	55°C	1 second	Controller loops back to Step 1, applying cooling until 20°C set point is reached. Steps 1 and 2 repeat seven more times. When the last loop has been completed, "Complete" appears on the display. Fluid temperature is maintained at 55°C until the set point is changed.

## Running a Temperature Program

NOTE: This function is available on Programmable Controllers only.

The Programmable Controller can store up to 10 user-defined time/temperature programs, which can later be run with just a few simple commands. See Entering/Modifying a Temperature Program above for more information.

Programs may be run using either a Time- or Temperature-based priority. This priority is selected under Program in the Preferences menu (see Setting Preferences below).

When Time is used, the program begins running when the bath temperature reaches the programmed set point for step one. It continues running until the total programmed length of time for all steps has elapsed, regardless of whether the set point temperatures for steps two and above have been achieved.

When Temperature is selected as the priority, the program begins running when the bath temperature reaches the programmed set point for step one. Each subsequent step is run until the programmed set point for that step is reached, regardless of how much time has elapsed.

Selecting a Program— To select a temperature program, rotate the Select/Set Knob until the Run Program menu appears and then press the Select/Set Knob.

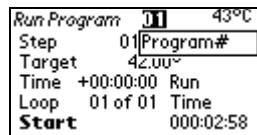

Run Program 01 43°C  
Step 01 Program#  
Target 42.00°  
Time +00:00:00 Run  
Loop 01 of 01 Time  
Start 000:02:58

If the Program # field is highlighted as shown above, press the Select/Set Knob and then rotate the Select/Set Knob until the number of the program you wish to run is displayed.

Press the Select/Set Knob a second time to accept the displayed program number. If the word **Start** is highlighted, rotate the Select/Set Knob one click counter-clockwise to highlight the program number.

Running a Program — Once you have selected and accepted the program number, rotate the Select/Set Knob until **Start** is highlighted. Press the Select/Set Knob; the program will automatically begin running. The word “Starting” will appear at the lower left of the Run Program menu and will remain there until the bath temperature reaches the set point programmed for step one. It will then be replaced by the word “Running.”

While a program is running, the Run Program and main operational displays will alternate on the LCD. The Run Program display shows the current step number, the target set point for the next step, time at the current step, loop number, program status, and total elapsed time. The main operational display shows bath temperature, set point, and program status.

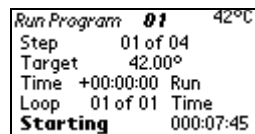

Run Program 01 42°C  
Step 01 of 04  
Target 42.00°  
Time +00:00:00 Run  
Loop 01 of 01 Time  
Starting 000:07:45



37.45 °C External  
37.33 Internal  
40.00 Starting

Pausing or Stopping a Program — A program that is running may be paused or stopped at any time. To do so, press the Select/Set Knob until **Starting** or **Running** is highlighted and then press the Select/Set Knob again. Rotate the Select/Set Knob until the desired function (Pause / Stop) is highlighted and then press the Select/Set Knob. If you do not wish to pause or stop the program, select and enter Escape.

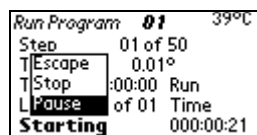

Run Program 01 39°C  
Step 01 of 50  
T Escape 0.01°  
T Stop :00:00 Run  
L Pause of 01 Time  
Starting 000:00:21

If the program has been paused, “Paused” will appear on the lower left of the display. If the program has been stopped, “Start” will appear on the lower left of the display.

To resume running a program that has been paused, press the Select/Set Knob, select Resume, and then press the Select/Set Knob a second time. The program will resume operation from the point of disruption. Select Stop if you wish to stop the program or Escape if you want to keep the program paused.

If a program is stopped or paused, the Controller will control temperature using the set point value that was active when the program was interrupted.

NOTE: If you select the Temperature Trend display while running a program, that display will remain on screen until the ESC Button is pressed.

**End of Program** — Once the selected program has run, “Completed” will appear in the lower left of the Run Program display. The Controller will keep the bath liquid at the last temperature set point until a new program is started or Run Program has been exited and a new set point entered.

**Exiting Run Program** — Once a program has been completed, “Completed” will appear at the lower left of the Run Program sub-menu. Highlight “Completed” and then press the Select/Set Knob. “Start” will appear. You may now return to manual set point control, run another program, or turn Controller power Off.

**Loss of Power** — If the Controller is placed in Standby (front panel power turned Off), the Controller will resume running the program when Controller power is restored. If main power (rear panel circuit breaker/power switch) is turned Off or electrical power is lost while a program is running, paused, or completed (but not exited), the appropriate Fault message will be displayed upon restoration of power (see Section 5.11 – Display Messages). Press the ESC Button to clear the Fault message; the Controller will resume operation at the set point at which power was lost. If the program was running or paused, it will not resume. If it was completed, it must be exited before a new program can be run.

### Setting Preferences

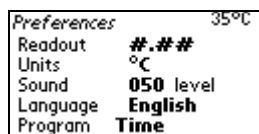

The Preferences sub-menu allows you program global preferences regarding instrument operation.

**Readout** — This is the number of decimal places to which temperatures will be displayed (0, 1, or 2).

**Units** — This is the unit in which temperatures will be displayed (°C or °F)

**Sound** — This is the volume level for the unit’s audible signal. When it is selected, the volume of the audible signal changes as the Select/Set Knob is rotated. You must press the Select/Set Knob to accept the displayed volume value; if you press the ESC Button or allow the display to timeout without pressing the Select/Set Knob, the sound level will remain where it was previously set.

**Language** — This is the language used for displays. When this is selected, a sub-menu appears with the available languages.



**Program** — This menu item appears only on the Programmable Controller. It is used to select whether programs are run using Time or Temperature as the priority.

When Time is selected, the program begins running when the bath temperature reaches the programmed set point for step one and continues until the total programmed period of time has elapsed. The set point target for any given step (except step one) may or may not be reached before the program advances to the next step.

When Temperature is selected as the priority, the program begins running when the bath temperature reaches the programmed set point for step one. Each subsequent step runs until the programmed set point for that step is reached, regardless of how much time has elapsed.

## Setting High/Low Temperature Limits and Alarms

Limits/Alarms	35°C
Limit High	200.00 °C
Alarm High	200.00 °C
Alarm Low	-50.00 °C
Limit Low	-50.00 °C

The Limits/Alarms sub-menu allows you to establish temperatures at which either power to the temperature control components (heater/condenser) will be disconnected (Limits) or which Controller's audible alarm will sound (Alarms).

**Limit High Temperature** — This feature provides additional safety and protection by allowing a selectable upper temperature limit set point. To avoid an unwanted shutdown during regular operation, the high limit value should be set at least 5°C higher than the selected control temperature. It should never be set higher than the Safety Set Set Point temperature (see Section 5.6)

If you attempt to enter a set point value that exceeds the Limit High value, the audible alarm will sound and a Warning message will flash on the display when the Limit High value is reached. You will also be prevented from increasing the set point value any further.

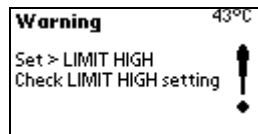

To clear a Limit High warning, enter a higher value for the Limit High or reduce the control temperature set point.

If the Limit High value is exceeded during operation (due to a Controller fault, excessive heat load, etc.), a Fault message will appear on the display and power to the heater and compressor will be disconnected. The pump will continue to run.

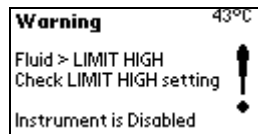

**Alarm High Temperature** — This feature is useful if you are using the bath to cool an external device. It alerts you when bath temperature exceeds your programmed alarm high temperature setting (due to insufficient cooling, blocked lines, etc.).

When the Alarm High value is exceeded, a Warning message flashes on this display and the audible alarm sounds. Heater, compressor, and pump operation continue.

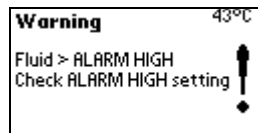

To clear an Alarm High warning, correct the problem or increase the Alarm High temperature value.

**Alarm Low Temperature** — This feature is useful if you are using the bath to warm an external device or need to maintain the bath at a minimum temperature. It alerts you when bath temperature falls below your programmed alarm low temperature setting.

When bath temperature falls below the Alarm Low value, a warning message flashes on the display and the audible alarm sounds. Heater, condenser, and pump operation continue.

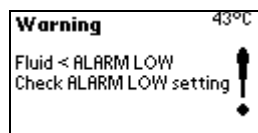

To clear an Alarm Low warning, correct the problem or decrease the Alarm Low temperature value.

**Limit Low Temperature** — This feature provides additional safety and protection by allowing a selectable lower temperature limit set point.

If you attempt to enter a set point value that exceeds the Limit Low value, the audible alarm will sound and a Warning message will flash on the display when the Limit Low value is reached. You will also be prevented from decreasing the set point value any further.

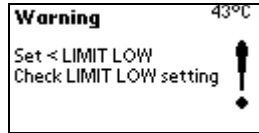

To clear a Limit Low warning, enter a lower value for the Limit High or increase the control temperature set point.

If the Limit Low value is exceeded during operation (due to a Controller fault, excessive cooling load, etc.), a Fault message will appear on the display and power to the heater and condenser will be disconnected. The pump will continue to run.

**Limits/Alarms Example**

- Initial Bath Temperature = 20°C
- Bath Temperature Set Point = 37°C
- Limit High Temperature = 60°C
- Alarm High Temperature = 40°C
- Alarm Low Temperature = 35°C
- Limit Low Temperature = 11°C

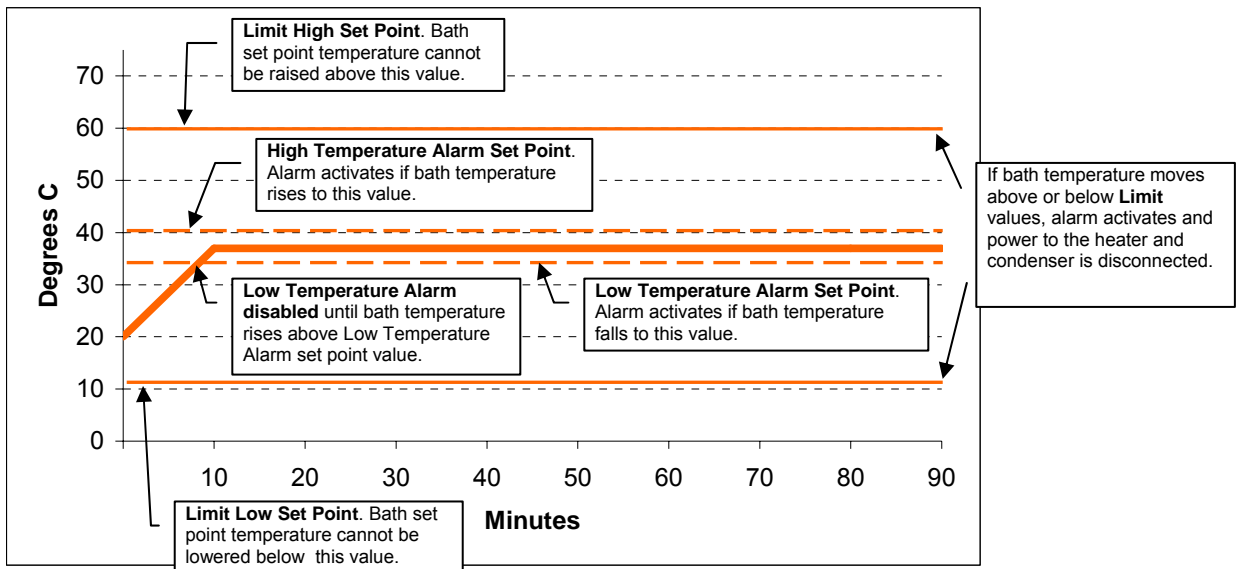

**Selecting the Pump Speed**

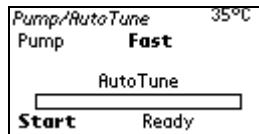

Pump speed is selected from the Pump/AutoTune menu. This display shows the current pump speed setting. Five pump speed settings are available – Maximum, Fast, Medium, Slow, and Minimum. See Section 3.1 for approximate pump pressures/flow rates at the various pump speed settings.

## AutoTune

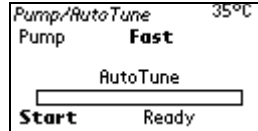

AutoTune is located in the Pump/AutoTune menu. This function allows you to optimize temperature stability by automatically adjusting the performance of the temperature control system to pump speed, fluid flow, and other variables. It is usually required only when the Circulator is being used to control the temperature of a large external tank or reservoir.

Selecting "Start" in this sub-menu initiates the AutoTune sequence. Once AutoTune begins, "Waiting" appears on the display along with a timer and % completed value. The percent complete is also displayed on a bar graph. An AutoTune sequence may take up to 2 hours to complete.

NOTE: As part of the AutoTune procedure, bath temperature will be raised approximately 8°C for a brief period of time and then returned to the original set point.

To stop the AutoTune operation, highlight "Waiting" and press the Select/Set Knob. A menu will appear with the following selections: Escape and Abort. Highlight "Abort" and then press the Select/Set Knob to stop the procedure; highlight Escape to resume the procedure.

Once the AutoTune procedure is complete, "Completed" will appear at the lower left of the display. Highlight the word "Completed" and press the Select/Set Knob. "Start" will appear and you can resume normal Controller operation.

You may reset the Controller to the original factory performance settings by selecting and accepting Reset Defaults from the AutoTune Start sub-menu.

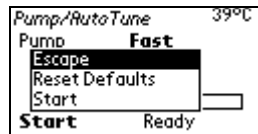

## Displaying the Bath Temperature Trend

The Controller can store up to 48 hours of bath temperature data. The data can be viewed by selecting Temperature Trend from the Main Menu.

To view the temperature trend data, rotate the Select/Set Knob until the Temperature Trend display appears, showing the most recent temperature data. The time period which the displayed trend line covers appears in the lower left corner of the display. It will range from two minutes to 48 hours.

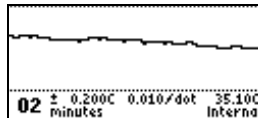

To view a different period of time, press the Select/Set Knob and then rotate it until the desired time period appears.

The temperature trend display will not timeout. To return to the main operational screen, press the ESC Button.

NOTE: If main power is turned off or power is accidentally lost, temperature trend data will be lost. If the Controller is put in "Standby" (main power On, Controller power Off), the data will be retained.



## Selecting the Temperature Probe (Internal or External)

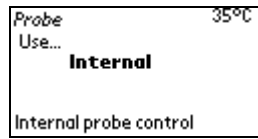

The Probe sub-menu allows you to designate whether to control temperature using the internal bath temperature or the fluid temperature at an external device. It is available on the Programmable Controller only and requires the use of an optional external temperature probe.

NOTE: If an external temperature probe is not connected to the Controller, only “Internal” will be available for selection. For information on connecting an external temperature probe, see Section 5.3.

When External is selected as the primary temperature probe, the Maximum Setpoint Differential setting becomes available.

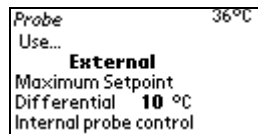

This allows you to set the maximum allowable difference between the set point temperature and the internal bath temperature. It is intended as a safety feature to protect the internal bath from over-heating or over-cooling in the event that the external temperature control set point cannot be achieved. The Maximum Setpoint Differential value may be set from 1° to 10°C. The factory default value is 10°C.

### Temperature Control / Display When Using an External Probe

When the difference between the set point temperature and internal bath temperature exceeds the programmed Maximum Setpoint Differential value, heating/cooling is controlled using the internal bath temperature. “Internal” is highlighted on the temperature display.



Control of the bath heating/cooling rate will be based on the internal bath temperature until the difference between the set point and the internal bath temperature is at the Maximum Setpoint Differential value. When the heating/cooling rate is being controlled using the external bath temperature, the word “External” is highlighted on the display.



NOTE: When the external temperature probe is in use, external bath temperature is displayed in large numerals, regardless of whether temperature control is based on the internal or external bath temperature.

## Setting the Auto-Refrigeration Temperature

Auto Refrigeration	36°C
Refrigeration ON when set is below	<b>40</b> (104°F)
Range	20 to 70°C

This menu item allows you to select the temperature at which refrigeration is activated. It is only present on Refrigerating/Heating models. For most applications, a set point that is 15 C above room temperature is recommended.

Cool Command Refrigeration — Refrigerating/Heating Circulators with 13 and 28 liter reservoirs feature the advanced **Cool Command™** modulating refrigeration control system. Cool Command Auto-Refrigeration has a broader range of control — from +20 C to 85 C — than conventional refrigeration. Additionally, it allows the refrigeration system to turn on at a fluid temperature up to 150 C when the temperature set point is changed to or below the Auto-Refrigeration set point (85°C maximum). As a result, bath fluid cools more quickly.

Conventional Refrigeration — Refrigerating/Heating Circulators with 6 liter reservoirs use a conventional refrigeration system. The Auto-Refrigeration control range on these is from +20 C to 70 C. The refrigeration system will turn on when the bath fluid temperature is below the Auto-Refrigeration set point (70°C maximum).

## Setting the Display Contrast and Timeout

Instrument	43°C
Contrast	<b>10</b>
Timeout	<b>60</b> seconds
Baud Rate	<b>57600</b>
Line Freq	60 Hz
Software	00D952F8



Display Contrast and Display Timeout appear as sub-menu items under Instrument in the Main Menu. These menu items allow you to change the readability of the LCD and set the length of time, which can pass without menu activity before the display will revert to the main operational display.



NOTE: When Contrast is selected, the display contrast will change as the Select/Set Knob is rotated. You must press the Select/Set Knob to accept the displayed contrast value; if you press the ESC Button or allow the display to timeout without pressing the Select/Set Knob, the display contrast value will remain where it was previously set.

## Setting the Baud Rate

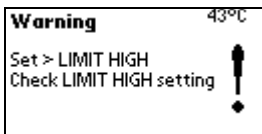
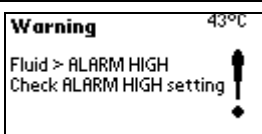
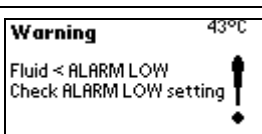
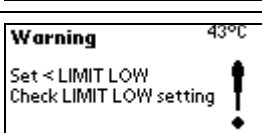
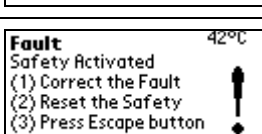
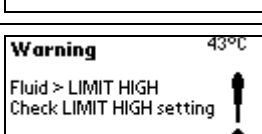
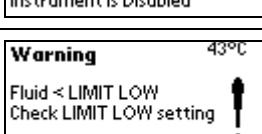
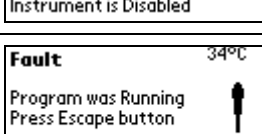
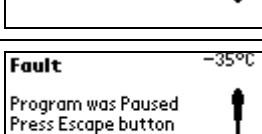
Instrument	42°C
Contrast	<b>10</b>
Timeout	<b>60</b> seconds
Baud Rate	<b>57600</b>
Line Freq	59 Hz
Software	00D952F8

This sub-menu selection also appears under Instrument in the Main Menu. It allows you to set the baud rate at which data will be transmitted over the RS232 interface. For more information on RS232 communication, see Section 5.4 and Section 11.1.

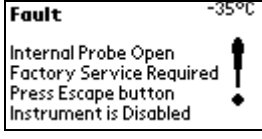
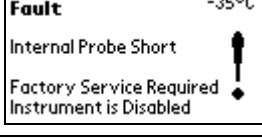
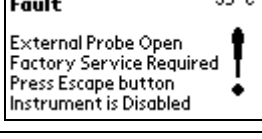
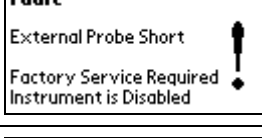
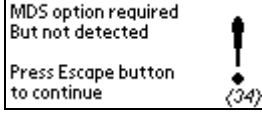
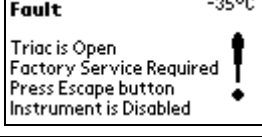
Message Display	Description	Action Required
 <p>Standby</p>	Standby mode	Normal — Indicates that the Circuit Breaker/Power Switch is ON and the Controller Power Switch is OFF
 <p><b>Warning</b> 43°C Set &gt; LIMIT HIGH Check LIMIT HIGH setting</p>	An attempt has been made to set the temperature set point higher than the Limit High setting	Error — Decrease temperature set point or increase Limit High setting
 <p><b>Warning</b> 43°C Fluid &gt; ALARM HIGH Check ALARM HIGH setting</p>	Fluid temperature is higher than the Alarm High setting	High Temperature Warning — Decrease temperature set point, increase Alarm High setting, or correct condition causing high fluid temperature. Pump, heater, and compressor operation continue.
 <p><b>Warning</b> 43°C Fluid &lt; ALARM LOW Check ALARM LOW setting</p>	Fluid temperature is lower than the Alarm Low setting	Low Temperature Warning— Increase temperature set point, decrease Alarm Low setting, or correct condition causing low fluid temperature. Pump, heater, and compressor operation continue.
 <p><b>Warning</b> 43°C Set &lt; LIMIT LOW Check LIMIT LOW setting</p>	An attempt has been made to set the temperature set point lower than the Limit Low setting	Error — Increase temperature set point or decrease Limit Low setting
 <p><b>Fault</b> 42°C Safety Activated (1) Correct the Fault (2) Reset the Safety (3) Press Escape button</p>	Safety Set temperature exceeded	Safety Fault — Power to heater, compressor, and pump automatically disconnected. Correct problem and then press Safety Set Reset Button and ESC Button to clear fault message and restore operation.
 <p><b>Warning</b> 43°C Fluid &gt; LIMIT HIGH Check LIMIT HIGH setting Instrument is Disabled</p>	Fluid temperature is higher than the Limit High setting	Safety Fault — Power to heater and compressor automatically disconnected. Decrease fluid temperature or increase Limit High setting. Pump will continue to run.
 <p><b>Warning</b> 43°C Fluid &lt; LIMIT LOW Check LIMIT LOW setting Instrument is Disabled</p>	Fluid temperature is lower than the Limit Low setting	Safety Fault — Power to heater and compressor automatically disconnected. Increase fluid temperature or decrease Limit High setting. Pump will continue to run.
 <p><b>Fault</b> 34°C Program was Running Press Escape button</p>	Indicates main power was lost while a program was running	Error — Program must be restarted. Press ESC Button to clear Fault message.
 <p><b>Fault</b> -35°C Program was Paused Press Escape button</p>	Indicates main power was lost while a program paused	Error — Program must be restarted. Press ESC Button to clear Fault message.
 <p><b>Fault</b> -35°C Program had Completed Press Escape button</p>	Indicates main power was lost after a program was completed, but before it was exited	Error — Press ESC Button to clear Fault message and then exit the program.

Message Display	Description	Action Required
	Analog to Digital conversion fault	Instrument Failure — Power to heater, compressor, and pump automatically disconnected. Contact supplier.
	Internal temperature probe fault	Probe Failure — Power to heater, compressor, and pump automatically disconnected. Contact supplier.
	Internal temperature probe fault	Probe Failure — Power to heater, compressor, and pump automatically disconnected. Contact supplier.
	External temperature probe fault	Probe Failure — Power to heater, compressor, and pump automatically disconnected. Replace external temperature probe or operate instrument using internal temperature probe. Contact supplier if fault persists.
	External temperature probe fault	Probe Failure — Power to heater, compressor, and pump automatically disconnected. Replace external temperature probe or operate instrument using internal temperature probe. Contact supplier if fault persists.
	Internal error	Error — Press ESC Button to continue operation. Contact supplier.
	Triac fault	Triac Failure — Power to heater, compressor, and pump automatically disconnected. Contact supplier.
	Internal memory fault	Failure — Power to heater, compressor, and pump automatically disconnected. Contact supplier.

## Section 6 - Maintenance and Calibration

### 6.1 Heater

The heater should be kept clean. If deposits build up on the heater, they may be removed by scrubbing with a non-metallic (plastic) abrasive pad. Do not use steel wool.

### 6.2 Pump Motor

The pump bearings are permanently lubricated with high-temperature silicone grease and do not require additional lubrication. Should the bearings become noisy, replacement of the entire pump motor is recommended. This will reduce repair labor costs and retain fluid pumping reliability.

A replacement pump and motor mounting kit is available (see Section 10 - Replacement Parts).

### 6.3 Cleaning

Only mild detergents and water or an approved cleaner should be used on the painted and stainless steel surfaces of the Circulator. Do not allow cleaning liquids or sprays to enter the Controller vents.

A concentrated bath cleaner is available that can be used to remove mineral deposits from the reservoir. See Section 10 - Replacement Parts.

### 6.4 Maintaining Clear Bath Water

When water is used as the bath fluid, optimal conditions are present for algae growth. To prevent algae contamination and minimize the need for draining the reservoir, an algicide should be used. See Section 10 - Replacement Parts.

Do NOT use chlorine bleach in the reservoir or on any pump parts.

### 6.5 Condenser, Air Vents, and Reusable Filter (Refrigerating/Heating Circulators Only)

To keep the refrigeration system operating at optimum cooling capacity, the condenser, the front and back air vents, and reusable filter should be kept free of dust and dirt. They should be checked on a scheduled basis and cleaned as required.

The reusable filter is easily accessed from the bottom/front of the unit. Turn the filter-retaining clip away from the filter cutout and remove the filter as shown in photo 6.5. Use a mild detergent and water solution to wash off any accumulated dust and dirt and then rinse and dry thoroughly before reinstalling.



Photo 6.5

### 6.6 Calibration

At times there may be a minor temperature difference between the Controller's displayed temperature and the actual temperature as determined by a certified temperature measurement device. There may also be situations where you want the displayed temperature to match a particular value to have standardization between different laboratory instruments. These adjustments can be performed via the Controller's password-protected calibration display(s).

To access the calibration display(s), rotate the Select/Set Knob until the Instrument Identification display appears. This is the last accessible screen as you rotate the Select/Set Knob counter-clockwise.

With the Instrument ID screen displayed, press and hold the Timer Button while also pressing the Select/Set Knob. A password box will appear on the Instrument ID screen.

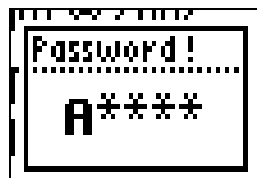

The Calibration access password is TUSER. It is case sensitive and entered by rotating the Select/Set Knob until the desired character appears and then pressing the Select/Set Knob. The

cursor will automatically advance to the next field in the password entry display. Once the final character is entered, rotate the knob and the following Calibration screen(s) will be available.

Calibration User	35°C
Offset	<b>0.00</b>
Result	34.26 °C
Result	93.65 °F
Internal Probe Calibration	
Offset Range	± 2.00°C

Calibration User	35°C
Offset	<b>0.00</b>
Result	35.84 °C
Result	96.49 °F
External Probe Calibration	
Offset Range	± 2.00°C

On Digital Controllers, only the Calibration User - Internal Probe Calibration will appear. On Programmable Controllers, the Calibration User – External Probe Calibration screen will also appear if an external probe is connected to the Controller.

To perform a calibration, go to the appropriate Calibration User screen and press the Select/Set Knob. Rotate the Select/Set Knob until the offset value equals the difference between the probe temperature reading and the reference temperature probe. Press the Select/Set Knob to accept the offset value.

NOTE: Allow the temperature reading at the probe to stabilize before making adjustments.

NOTE: The Calibration User display(s) remains available only while Controller power is On. If the Controller is placed in Standby or main power is disrupted, the display(s) will have to be re-enabled by entering the Calibration access password.

## Section 7 - Troubleshooting

- 7.1 Unit Will Not Operate (no heat, cooling, or pumping)
- Check that the power cord is plugged in to an operating electrical outlet.
  - Check that the Circuit Breaker/Power Switch is ON.
  - Check that the Controller Power Switch is ON.
  - Check that the Safety Set temperature is higher than the control temperature set point.
  - Reset Safety Set by pressing the Safety Set Reset button and then the ESC Button.
- 7.2 No Pumping
- Check the fluid level of the bath to be sure the pump head is covered with fluid.
  - Check the pump impeller for obstructions (it should turn freely).
- 7.3 Slow or Insufficient Pumping
- Check for low line voltage, particularly when the heater is on.
  - Check for too small of a hose diameter (closed loop applications).
  - Check for too high of a fluid viscosity.
- 7.4 No Heating
- Verify that the unit is pumping properly.
  - If the heat light is not lit, check the control temperature set point and bath temperature to verify that heating is required.
  - Verify that the liquid in the bath covers the heater coils.
  - Check that the Limit High value has not been exceeded (Warning message appears on the display).
- 7.5 Insufficient Heating
- Verify that the unit is pumping properly.
  - Check for proper line voltage.
  - Check for excessive external cooling load on unit.

- At higher temperatures, insufficient heating could be due to excessive heat loss from tanks, hoses, or vapor from the tank.
- Check that the heat demand from connected devices or experiments does not exceed the heating capabilities of the unit.
- Allow sufficient time for bath temperature to stabilize when changes in heat load or set point are made.

#### 7.6 No Cooling or Insufficient Cooling

- If the cooling light is not lit, check the control temperature set point and bath temperature to verify that cooling is required.
- Check for low or high line voltage.
- Check for blocked airflow through ventilation screens.
- Check ambient air temperature. Refrigeration unit should not be operated above 32°C ambient temperature as high air temperature may cause the refrigeration compressor to temporarily shut down.
- Check for excessive heat being transferred to the bath liquid as this may exceed the cooling capacity of the refrigeration system.

#### 7.7 Triac Failure

- Triac is Open fault message appears on the display, indicating that the heater triac has failed or the line supply voltage has a source of extreme interference from other equipment. Plug the unit into another power source. If it still displays triac failure, a triac or triac driver needs replacement.

#### 7.8 External Probe Failure

- External Probe Open or External Probe Short fault message appears on the display, indicating that the external probe has failed or there is a problem with the circuitry reading the probe signal. Replace the external probe; if the problem persists, an internal PCB needs replacement.

#### 7.9 Recalling the Power-Up Language Selection Menu

The first time the Controller is powered up, a language selection menu is displayed which allows the user to select the language used for operational displays and programming. This is a one-time display; the next time the Controller is powered up, either Standby or the main operational display will appear once the initial self-test procedure has been completed.

You may change the language used for operational and programming displays in either of two ways. One is to change the language using the Preferences sub-menu (see Section 5.10). The other is to recall the initial power-up language selection display. This is performed as follows.

1. Press the Power Button to turn Controller power off (Standby displayed).
2. Place the circuit breaker/power switch on the rear panel in the Off position (display blank).
3. Press and hold ESC Button.
4. Place the circuit breaker/power switch in the On position; continue holding ESC Button.
5. Release the ESC Button when the language selection menu is displayed.
6. Rotate the Select/Set Knob until the desired language is highlighted.
7. Press the Select/Set Knob.

The Controller will complete the start-up sequence and display "Standby" on the LCD. All operating and programming screens will now be displayed in the selected language.

## Section 8 - Reservoir Fluids

Depending on your needs, a variety of fluids can be used with your Circulator. No matter what bath medium is selected, it must be chemically compatible with the reservoir and with the 300 series stainless steel in the pump and heater. It must also be suitable for the desired temperature range. Always use fluids that satisfy safety, health, and equipment compatibility requirements.

For optimum temperature stability, the fluid's viscosity should be 50 centistokes or less at its lowest operating temperature. This permits good fluid circulation and minimizes heating from the pump.

For temperatures from 10°C to 90°C, distilled water is recommended. For temperatures below 10°C, a mixture of laboratory grade ethylene glycol and water should be used. Do not use deionized water.

The following chart is intended to serve as a guide in selecting a bath fluid for your application. For optimum temperature stability and low vaporization, be sure to stay within the fluid's normal temperature range.

**You are responsible for proper selection and use of the fluids.**

**Avoid extreme range operation.**

FLUID DESCRIPTION	SPECIFIC HEAT @25°C	NORMAL RANGE	EXTREME RANGE
Distilled Water	1.00	10° — 90°C	2° — 100°C
Ethylene Glycol 30% / Water 70%	.90	0° — 95°C	-15° — 107°C
Ethylene Glycol 50% / Water 50%	.82	-20° — 100°C	-30° — 100°C
Dynalene-HC 50	.76	-50° — 60°C	-62° — 60°C
DC200, 5 cs Silicone Oil	.32	-35° — 65°C	-50° — 125°C*
DC200, 10 cs Silicone Oil	.34	-20° — 80°C	-35° — 165°C*
DC200, 20 cs Silicone Oil	.36	0° — 100°C	-10° — 230°C*
DC200, 50 cs Silicone Oil	.39	50° — 150°C	5° — 270°C*
DC510, 50 cs Silicone Oil	.39	50° — 150°C	5° — 270°C*
DC550, 125 cs Silicone Oil	.42	100° — 200°C	80° — 232°C*
DC710, 500 cs Silicone Oil	.45	150° — 250°C	125° — 260°C*

\*WARNING - Fluid's flash point temperature

DC fluids are manufactured by Dow Corning. Dynalene HC is a registered TM of Advanced Fluid Technology Inc.

### DO NOT USE the following fluids:

1. Automotive antifreeze with additives\*\*
2. Hard tap water\*\*
3. Deionized water with a specific resistance > 1 meg ohm
4. Any flammable fluids
5. Concentrations of acids or bases
6. Solutions with halides: chlorides, fluorides, bromides, iodides or sulfur
7. Bleach (Sodium Hypochlorite)
8. Solutions with chromates or chromium salts

\*\* At temperatures above 40°C, additives or mineral deposits can adhere to the heater. If deposits are allowed to build up, the heater may overheat and fail. Higher temperatures and higher concentrations of additives will hasten deposit build up.



**Warning:** Do not use a flammable liquid as a bath medium as a fire hazard may result. Be aware of the flash point temperatures for the fluids used.



**Application Notes**

At a fluid's low temperature extreme:

1. The presence of ice or slush adversely affects temperature stability.
2. A viscosity above 10 centistokes adversely affects temperature uniformity.
3. A high fluid viscosity and high pump speed adds heat to the fluid being pumped.

At a fluid's temperature above ambient without refrigeration:

1. To avoid friction heating of the fluid, the viscosity of the fluid should be 10 centistokes or less and within 15°C of room temperature.
2. Heat loss should be encouraged by uncovering the fluid and lowering the pump speed.

At a fluid's high temperature extreme:

1. Heat loss from vapor adversely affects temperature stability.
2. To prevent the accumulation of vapors inside the room, the reservoir may need to be placed in a fume hood.
3. Use a cover and/or floating hollow balls to help prevent heat and vapor loss.
4. Replenish fluid lost from vapor frequently.

## Section 9 - Service and Technical Support

If you have followed the troubleshooting steps outlined in Section 7 and your Circulator still fails to operate properly, contact the supplier from whom the unit was purchased. Have the following information available for the customer service person:

- Model, Serial Number, and Voltage (from back panel label)
- Date of purchase and purchase order number
- Supplier's order number or invoice number
- A summary of the problem

## Section 10 - Replacement Parts

<b>Description</b>	<b>Part #</b>
Lab Algicide, concentrate, 8 oz.	004-300040
Bath Cleaner, concentrate, 8 oz.	004-300050
Bath Cleaner, concentrate, 16 oz.	004-300052
Dynalene HC™, 1 gallon	060330
Dow Corning® 510, 1 gallon	060326
Dow Corning® 550, 1 gallon	060327
Dow Corning® 710, 1 gallon	060328
Assembly, Front Bezel, 120-240V	510-247
Pump Motor, 120V	215-331
Pump Motor, 240V	215-332
Power Supply Board, 120V	500-218
Power Supply Board, 240V	500-219
Heater, Tubular, 1.1kw, 120V	215-119
Heater, Tubular, 2.2kw, 240V	215-215
Fan, Refrigeration, 6 liter bath, 120V	215-196
Fan, Refrigeration, 6 liter bath, 240V	215-197
Fan, Refrigeration, 13 or 28 liter bath, 120V	750-006
Fan, Refrigeration, 13 or 28 liter bath, 240V	750-021
Compressor Control PCB, 6 liter bath, 120-240V	500-225
Parker Control PCB, 13 or 28 liter bath, 120V	500-223
Parker Control PCB, 13 or 28 liter bath, 240V	500-224
Circuit Breaker	215-330
AC Mains Connector, 15A	215-397
External Probe, RTD, 10 Ft.	060101
Cable, Serial, Monitor Ext	225-173
IEC Power Cord	225-227
Manual, Programmable/Digital Controller Operators	110-238

## Section 11 - Appendix

### 11.1

#### RS232

**Serial Connector** — A 9-pin D-connector is provided on the back panel of the Controller for RS232 data communication. A serial cable that uses only the following pins should be used to connect the Controller to the computer:

- Pin #2 — data read (data from computer)
- Pin #3 — data transmit (data to computer)
- Pin #5 — Signal ground

**IMPORTANT:** Use a standard three wire RS232 cable only.

**RS232 Protocol** — The Controller uses the following RS232 protocol:

- Data bits — 8
- Parity — None
- Stop bits — 1
- Flow control — None
- Baud rate — Selectable (Controller/PC baud rates must match). 57600 is recommended.

**Communications Commands** — Commands must be entered in the exact format shown. Do not send a [LF] (line feed) after the [CR] (character return). Be sure to follow character case exactly.

A response followed by an exclamation point (!) indicates that a command was executed correctly. A question mark (?) indicates that the Controller could not execute the command (either because it was in an improper format or the values were outside the allowable range). A response must be received from the Controller before another command can be sent. All responses are terminated with a single [CR].

Command	Format	Values	Return Message
Set Command Echo	SEi[CR]	Echo: i = 1 No Echo: i = 0	![CR]
Set Set Point	SSxxx.xx[CR]	x = ascii digit	![CR]
Set On Off	SOi[CR]	On: i = 1 Off: i = 0	![CR]
Set Power Status	SWi[CR]	Set: i = 1 Reset: i = 0	![CR]
Set High Alarm	SHxxx.xx[CR]	x = ascii digit	![CR]
Set Low Alarm	SLxxx.xx[CR]	x = ascii digit	![CR]
Set Remote Probe	Sri[CR]	Internal: i = 0 External: i = 1	![CR]
Get Set Point Temperature	RS[CR]		![CR]
Get Internal Temperature	RT[CR]		![CR]
Get External Temperature	RR[CR]		![CR]
Get Power Status	RW[CR]	x = ascii digit	x[CR]
Get Temperature Units	RU[CR]		C[CR] or F[CR]
Get High Alarm	RH[CR]		xxx.xx[CR]
Get Low Alarm	RL[CR]		xxx.xx[CR]
Get Alarm Status	RF[CR]	Returns: 0 = No alarm Reset: 1 = Alarm	![CR]

The following commands are functional with Programmable Controllers only			
Set Program Number	SVx[CR]	x = ascii digit	![CR]
Set Program Number Steps	Ssxx[CR]	x = ascii digit	![CR]
Set Program Last Loop Number	SKxx[CR]	x = ascii digit	![CR]
Set Program Step Set Point	SYn,xxx.xx[CR]	n = step number x = ascii digit	![CR]
Set Program Step Period	SXn,xxx.xx[CR]	n = step number x = ascii digit	![CR]
Set Program Hold	SZi[CR]	i = 0 (Off) i = 1 (On)	![CR]
Set Program Operation	SGi[CR]	i = 0 (Stop) i = 0 (Go)	![CR]
Set Program End	SR[CR]		![CR]
Set Program Skip Period	SJ[CR]		![CR]
Get Program Number	RV[CR]	x = ascii digit	x[CR]
Get Program Number Steps	Rs[CR]	x = ascii digit	x[CR]
Get Program Number Loops	RK[CR]	x = ascii digit	xx[CR]
Get Program Loop Number	RI[CR]	x = ascii digit	xx[CR]
Get Program Set Point Step	RYn[CR]	n = step number	xxx.xx[CR]
Get Program Set Period	RXn[CR]	n = step number	xxx.xx[CR]
Get Program Step Number	RC[CR]	x = ascii digit	xx[CR]
Get Program Elapsed Step Time	RE[CR]	x = ascii digit	xxx.xx[CR]
Get Program Status	RG[CR]	Stop = 0 Running = 1 Paused = 2	![CR]

## 11.2

### Microsoft Excel Macro

Programmable Controllers come with a compact disc containing a Microsoft® Excel macro that enables you to collect temperature data from the Controller, download time/temperature programs from the Controller, and/or create and upload time/temperature programs to the Controller. The program is named **PSC-T12-Reader**.

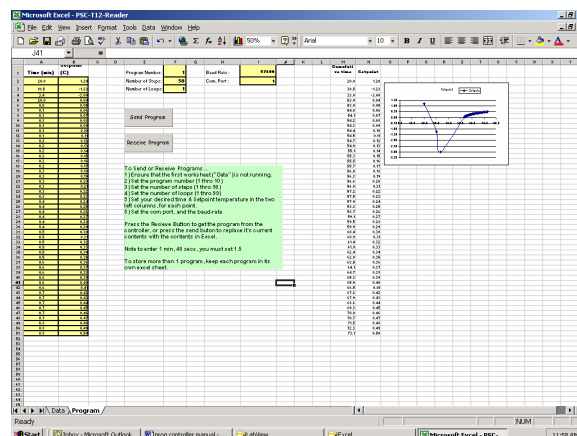

NOTE: This program has not been tested with all the possible combinations of the Windows operating system (95, 98, Me, etc.) and Microsoft Excel (95, 98, 2000, etc.). Due to idiosyncrasies in

these programs, the macro may not function properly with your particular Windows/Excel combination. The use of Windows XP and Excel XP is recommended.

To install the macro, simply copy it to your computer desktop or other hard drive location. Launch the program as you would any Excel spreadsheet.

The following are required to run the program:

1. Macros must be enabled.
2. The baud rate selection in the program and the Controller's baud rate must match (57600 is recommended).

Instructions for using the macro appear on the PSC-T12-Reader spreadsheet.

### 11.3 National Instruments LabView Plug-in

The compact disc supplied with the Programmable Controller also includes a folder named PSC12. The contents of this folder permit you to use the Controller with National Instruments LabView™ 6.

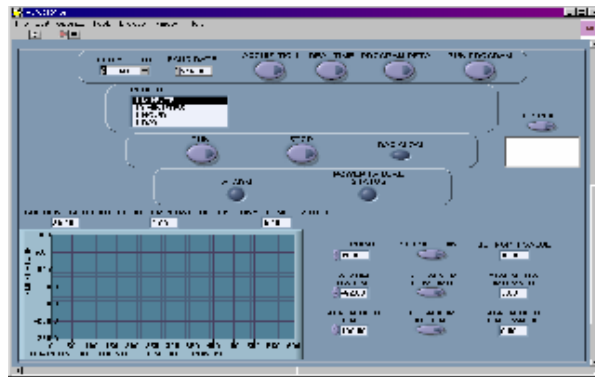

The entire folder should be copied to the following location on your computer:

C:\Program Files\National Instruments\LabView 6\instr.lib

Once the folder is copied to this location, you should be able to use LabView to communicate with your Programmable Controller as you would any other connected device.

Microsoft is a registered trademark of Microsoft Corporation.  
LabView is a registered trademark of National Instruments Corporation.

Section 12 – EC Declaration of Conformity

**EC Declaration of Conformity**



The Products herewith complies with the requirements, as stated below, in accordance to the EC Low Voltage Directive 73/23/EEC and EC Electromagnetic Compatibility Directive 89/336/EEC, and carries the **CE** marking accordingly.

We herewith declare: PolyScience  
Division of Preston Industries, Inc.  
6600 West Touhy Avenue  
P.O. Box 48312  
Niles, Illinois 60714, USA

That the following equipment complies with the essential requirements in respect to safety and health, in accordance to the EC Directives based on its design and type, as brought into circulation by us. In case of alteration of the equipment, not agreed upon by us, this will lose its validity.

Product Description: Refrigerated/Heated Circulators  
13R, 712, 7306, 7312, 812, 8006, 8012, 8002, 8112, 8102, 8106, 8202, 8212, 8206, 8306, 9006, 9012, 9002, 912, 9112, 9102, 9106, 9502, 9512, 9506, 9602, 9612, 9606, 9702, 9712, 9706;  
  
18203, 18214, 18211, 18210, 18201, 18206, 18205, 18208, 18212, 18207, 18225, 18226, 18202;  
  
13270-879, 13270-880, 1112A, 1122S, 1127P, 1146D, 1140S, 1147P, 1162A, 1166D, 1160S, 1167P, 1156D, 1150S, 1157P, 1196D, 1190S, 1197P, 1186D, 1180S, 1187P, 1136D, 1130S, 1137P, 1136-1D, 1130-1S, 1137-1P, 1136-2D, 1130-2S, 1137-2P;  
  
12110-00, 12110-05, 12112-01, 12112-06, 12112-11, 12112-16, 12112-12, 12112-26, 12100-10, 12100-15, 12100-20, 12100-25, 12108-00, 12108-05, 12108-20, 12108-25, 12108-10, 12108-15, 12108-30, 12108-35, 12102-10, 12102-15, 12102-00, 12102-05, 12103-20, 12103-25, 12105-70, 12105-75, 12101-41, 12101-46, 12101-31, 12101-36, 12101-51, 12101-56, 12111-11, 12111-16, 12111-01, 12111-06, 12111-21, 12111-26, 12107-00, 12107-05, 12107-20, 12107-25, 12107-10, 12107-15, 12107-30, 12107-35, 12107-50, 12107-55, 12107-40, 12107-45, 12107-60, 12107-65, 98928-30, 98928-35.

Applicable Directives and Harmonized Standards: Low Voltage Directive 73/23/EEC & Electromagnetic Compatibility 89/336/EEC and relevant transpositions into national law of the member states, including, but not limited to the following  
Harmonized Standards:  
EN/IEC 61010-1: 2001  
EN 61326: 1997 +A1: 1998 + A2:2001  
CISPR 11/EN 55011 Class A, Group I

Testing Bodies: CSA International (Certification & Testing Division)  
Ultra Tech Inc. ( EMC approval)

Signature on Behalf of  
Manufacturer or Authorized  
Representative:

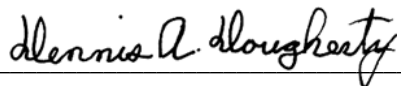
Dennis A. Dougherty 

Date of Validity:

February 9, 2004

Title of Signatory:

Engineering Manager